

FOR OVER

40
YEARS

THE BEST WAY
HAS BEEN THE
ECOSTAR WAY!

YOUR COMPLETE GUIDE TO WINDOWS

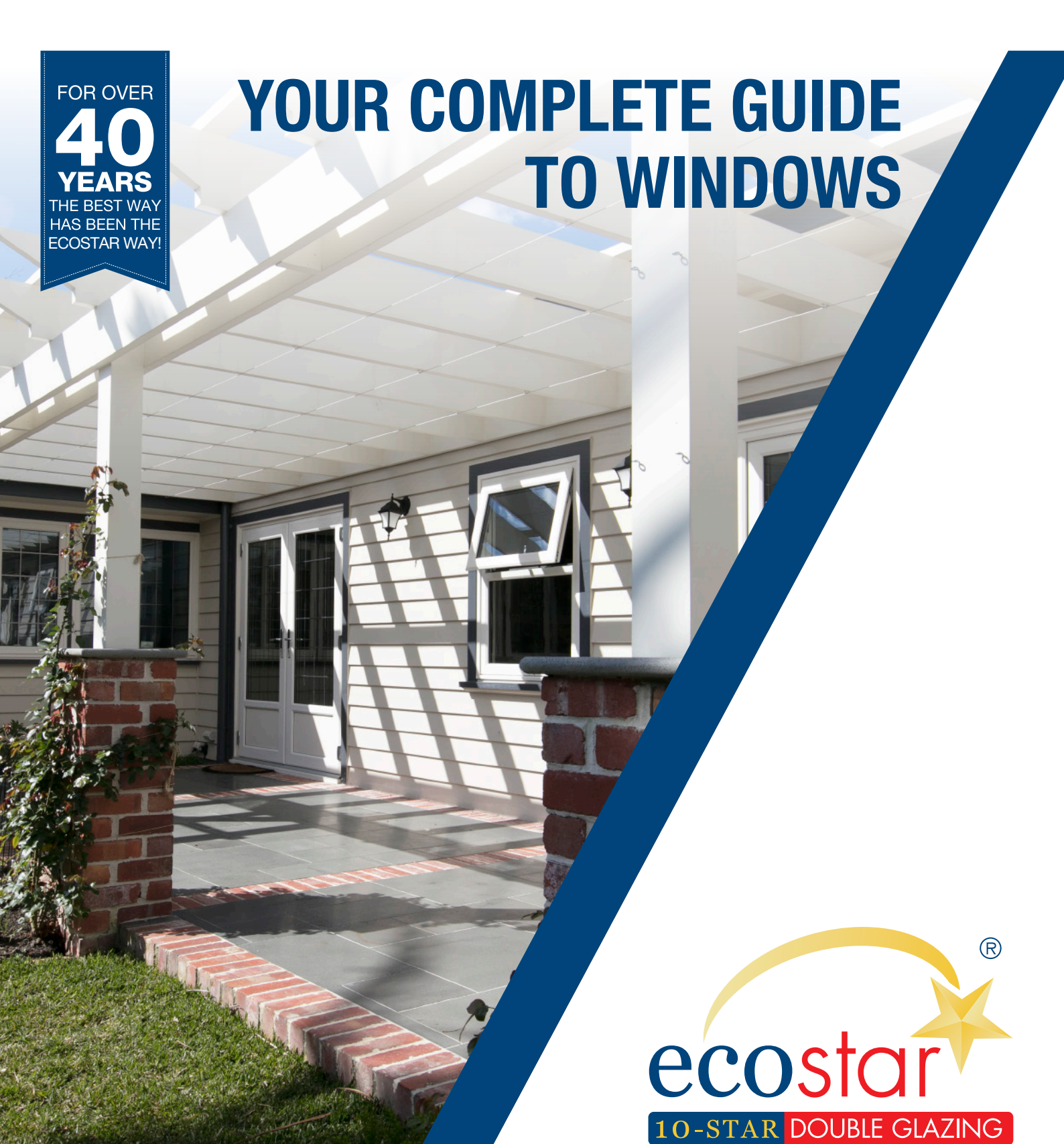

Are you a homeowner looking for a new set of windows for your home? Well, you've come to just the right place. This handy buying guide contains all the information you need to know to find the right windows for you. As a manufacturers and installer of windows for over 40 years, we've got experience across each individual aspect, including hardware, glass, frames and materials. We've also interacted with thousands of homeowners during this time, so we've had the chance to learn exactly what they are looking for when buying new windows.

T: 1300 963 231 | E: sales@ecostardoubleglazing.com.au

www.ecostardoubleglazing.com.au

A FAMILY RUN BUSINESS SINCE 1979, ALWAYS SMALL ENOUGH TO CARE BUT CERTAINLY LARGE ENOUGH TO COPE

WHICH WINDOW MATERIAL IS BEST?

When in search for the ideal set of windows, you first need to know the types of materials they're constructed from. Whilst the idea that different material = different characteristics is true to some extent, there remains a number of similarities amongst uPVC, aluminium and timber, the three main construction materials.

uPVC

uPVC windows are incredibly energy efficient and can easily attain energy ratings of 6 Star and above. They can also be well maintained with minimal effort and achieve excellent security ratings. Be sure to check that the uPVC has been correctly engineered for the Melbourne climate.

The lifespan of well-maintained uPVC windows is around 40 years.

uPVC is considered by some to be less visually appealing than the other materials. Woodgrain textures can now be applied to it, which do a fantastic job replicating the appearance of actual timber. A plentiful supply of colour finishes are available too.

Ecostar manufactures all of our uPVC products. Therefore, directly influencing quality control.

Aluminium

Aluminium is stronger than uPVC and timber, which is why it is a material commonly used in commercial and Government properties where the government is paying the energy bill and the products experience extreme use over a long period of time.

Whilst modern aluminium windows have undergone improvements to their thermal performance, they lag behind uPVC and timber in this respect and corrode and colour fade over time. Contemporary manufacturing still provides openings that are hard to keep sealed effectively over time.

Timber

Aesthetically, timber has a timeless quality.

Timber is a great insulator but it is difficult to keep properly sealed and closed in climates with large variations in humidity, such as Melbourne.

Unlike the other window materials, timber can be repainted a different colour at a later time. This means you can change their look as your tastes or the appearance of your home changes, if painted however, they will require regular maintenance and further painting



WILL ANY WINDOW MATERIAL SUIT THE STYLE OF MY HOME?

If you're replacing windows that are particularly old, whichever material you choose, your new windows are almost guaranteed to offer improved performance levels.

However, the material best suited to your needs may depend on the location of the windows you're replacing. For instance, if you're replacing windows in a north-facing room which sees very little light, you might be thinking about how to allow more light into the room.

It is usually possible to have any window fitted on your home. Plus, what looks good to you will look terrible to someone else, so ultimately it's your decision. However, if you replace your windows with a set that doesn't complement the property, you may reduce the property's resale value. So, it's beneficial to have an understanding of which materials tend to be better suited to specific properties.



Replacing windows in period properties

uPVC windows can replicate the look and feel of timber windows. They also come with a dual colour option, allowing you to match your new windows to your home's interior and exterior. If you're looking for increased compatibility with the inside and outside of your home, these may actually constitute the better option.



Weatherboard houses

Weatherboard houses tend to be fitted with timber windows. If you would like to retain this appearance you can purchase new timber windows or you could choose to replace them with the modern, zero maintenance equivalent. uPVC windows are available with a wide range of colour options, allowing you to retain their original styling but add your own unique touch.



Finding windows to suit your modernist home

The focus on these properties is usually on minimalism and clean, sharply defined lines. uPVC windows tend to fit this description better than the other materials, meaning they're ideal for this type of property.

WHAT ARE THE TYPES OF WINDOW?

Equally as important as the window's material is the style. Which style is right for you will depend on your individual preferences, as well as your practical requirements. Most windows are able to be hung either from the top, side or from the bottom.

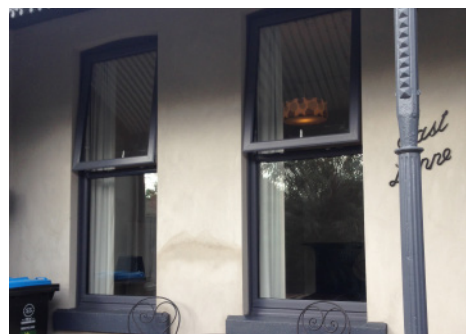

Casement & Awning Windows

Casement windows are the most popular of the window styles. They're extremely versatile, open outwards and can be hung either from the top or side, depending on individual requirements.

Flush Sash Windows

Flush sash windows are defined in this way because they close flush into the outer frame, rather than protruding out. This results in a stylish appearance which, when combined with symmetrical, clean lines, allows them to emulate traditional timber windows. They used to be constructed from timber, however uPVC variants are now available. Modern sash windows tend to allow more light in than older variants. This is thanks to a smaller opening device.



Vertically Sliding & Double Hung Windows

As they emulate a 17th century window aesthetic, timber is, arguably, the only option for those looking for a true replication of vertically sliding windows. The sightlines on timber versions are also impeccably slender, ensuring your home will benefit from lashings of natural light. However, they're also available in uPVC, which look stunning and will require less maintenance over their lifetime. Vertical sliding windows are operated via a vertically sliding mechanism, hence the name. They're suitable for a range of window layouts, including square bay, angled bay and bow.

Tilt & Turn Windows

In order to allow for safe, easy cleaning and maximum ventilation, tilt & turn windows can be fully opened internally. They're operated via a dual hinge arrangement, allowing you to 'tilt' them inwards, ventilating your home without the risk of children climbing through them. This means they're ideal in any locations above a storey in height, or as a servery window



WHAT ARE THE TYPES OF WINDOW?



Special Shaped Windows

Some companies offer windows in a variety of special shapes, including hexagons, arches and circles. They can be good for adding a touch of personalisation to your home, however they can also serve functional purposes. For example: certain areas of the home might have an odd shape, so fitting a square window might look out of place and detract away from the property's visual appeal. In such cases, a specially shaped window can add light and ventilation to these areas without negatively impacting the appearance.





OTHER CONSIDERATIONS WHEN CHOOSING YOUR NEW WINDOWS

Ultimately, this depends on your practical and visual requirements but here are a few alternative considerations to account for.

1. Due to their versatility, casements can be adapted to suit most projects. However, if you're looking to replace windows that are high up and you've got young children running around your home, you might consider tilt & turn windows. They offer increased ease of cleaning too.
2. The customisation options of each style will vary slightly, however there's always an opportunity to put your own unique stamp on them, whichever you choose. This can include the style of framing, the glass and a range of window accessories.
3. If you reside in a listed home, or heritage overlay home always contact your local planning authority to talk through your options. Replacing windows in these areas can be a lengthy process.





GLAZING OPTIONS

Since the 1970s, double glazing has become the norm for European homeowners. However, advancements in technology mean that there is a stark contrast in quality between double glazed windows of the 1970s and those on offer today. Understanding how types of glazing work is important and can help to inform you on which glazing option best suits your requirements.

Single Glazing

In Melbourne, a surprising amount of homes still have single glazed windows. Whilst they keep heat in and noise out to some extent, they're unable to do so as well as double glazing. They're also much more of a security risk as they only use a single pane of glass, which is relatively easy to break.

They do still have their place, however, particularly in areas that are subject to conservation guidelines. In such areas, single paned windows with timber frames are often found and due to the restrictions, a like for like replacement is the only window option available.

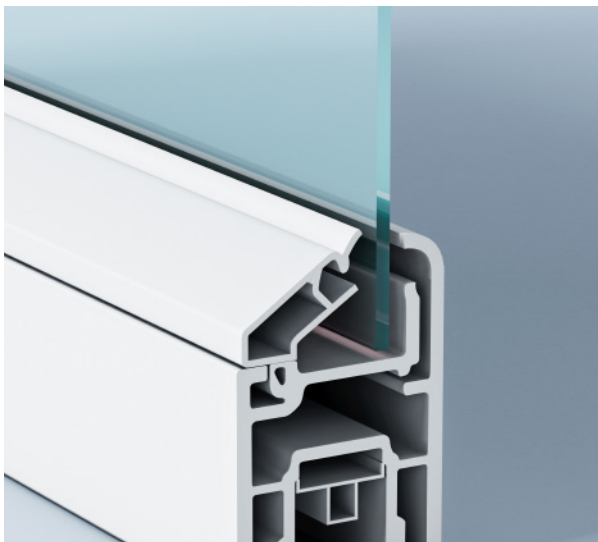

Double Glazing

As standard, quality windows are fitted with double glazing. In 2016, 83% of European homes were fully double glazed, with an additional 10% having more than half their windows double glazed. Double glazing ensures for strong levels of energy efficiency, contrary to popular belief this includes warmer climate countries such as Spain, Greece and France. Double Glazing ensures security and soundproofing, resulting in a comfortable, secure home environment. For most homes, this option will be more than adequate.

Double glazed windows are made up of two panes of glass which are separated by a small cavity. This small cavity is usually filled with an inert gas, such as Argon, however sometimes a vacuum is used. The combination of the cavity and inert gas reduces the amount of heat that's able to escape, or enter your home through the window considerably.

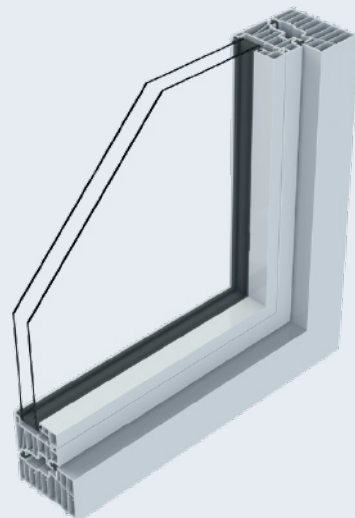

WHAT ARE THE DIFFERENT TYPES OF GLASS FOR WINDOWS?

A major component of any window is the glass. It has been used for centuries and plays a key role in allowing light inside as well as keeping noise and the weather out. Glass technology has advanced considerably since it's initial use, and now homeowners have a plethora of glass options available to choose from.

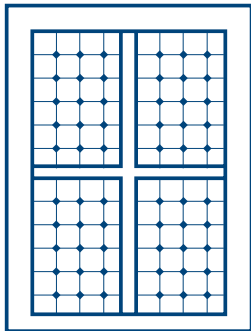

Decorative Glass

You can put your own unique stamp on your windows by incorporating a decorative pattern onto the glass. These are available in a plentiful supply of shapes, sizes and patterns. Many consider a glass design to be more attractive than plain glass. Specific designs or styles may also be better suited to achieving a certain type of aesthetic. Stained glass designs can be replicated in double glazed windows.

Privacy Glass

Privacy glass obscures the view through the window, making it more difficult for onlookers to view the inside of your home. It's often found on back doors and bathroom windows for this reason, however porches and entrance doors often use it too. Despite concealing the inside of your home, it has no negative impact on the amount of light that's able to get in. It's available in a range floral, Minster and cloudy glass designs.



Sound Reduction Glass

Windows fitted with sound reduction glass feature an incredibly broad outer pane and a thicker inner pane. They reduce the amount of noise coming into your home considerably. If you'd like for less noise to come into your home, sound reduction glass is ideal for you.

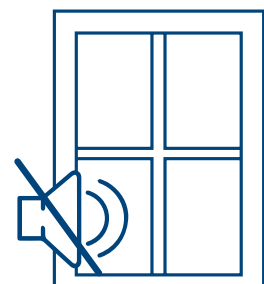

WHAT ARE THE DIFFERENT TYPES OF GLASS FOR WINDOWS?

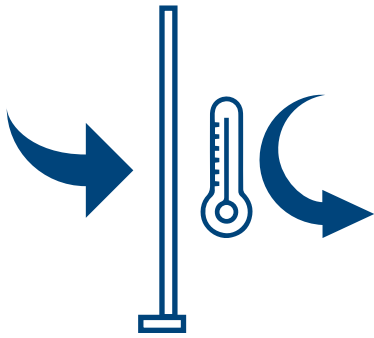

Low-e Glass

Utilising an invisible coating, low-e, or low emissivity, glass works by reflecting heat back inside your home. It also allows more solar radiation through than standard glass, leading to an increase in heat through passive solar heat gain. This ensures for a warmer home in the winter time.

Toughened Glass

There are other terms for toughened glass, namely laminated or security glass. It's typically thicker than standard glass and can be up to 5 times as strong. For those who are looking to bolster the security levels of their windows, it's worth considering.



WHAT ARE THE DIFFERENT TYPES OF WINDOW FRAMES?

Another essential part of any window is the frames. The manufacturing process is different depending on the material being used.



uPVC Window Frames

Modern uPVC window frames are fitted with multiple chambers of air. The use of multiple chambers allows more heat to be trapped inside the frame, resulting in an improved thermal performance. Most modern uPVC windows feature at least 3 chambers, however some, including Ecostar windows, have as many as 9. More chambers improves the window's thermal performance.



Aluminium Window Frames

Aluminium windows are constructed a bit different nowadays than they were in the past. Traditionally, they could only be made in one piece, which had a negative impact on the thermal efficiency of the window. This is because metals tend to conduct heat well, meaning more of it is able to escape out the home. However, some modern aluminium windows are now constructed in two parts and a polyamide thermal break has been added into the framing.



Timber Window Frames

Unlike other materials, which use chambers or other materials to increase their thermal performance, timber frames don't require any additional parts. This is because of timber's natural insulating qualities. To construct timber windows, pre-cut lengths of wood are fitted together. The lengths will be cut either by a machine or by hand.



STYLES OF WINDOW FRAMING

How the window frame is styled will affect how well the window fits your property. We've looked into the different styles of window framing that are available, in order to give you an idea of which is likely to be better suited to your home.



Chamfered Frames

These are also referred to as bevelled and feature a flat, streamlined profile. Chamfered frames tend to be slimmer, meaning more glass is present and more glass = more light coming through the window. Because of their clean, slender appearance, they're often considered ideal for achieving a contemporary aesthetic. New builds, as well as many 1920s style properties, such as mock Tudor houses, are often fitted with windows featuring chamfered frames.

Ovolo Frames

Ovolo framing is curved in shape and is often considered the best choice for cottages and period properties. However, ovolo frames are often found on larger windows. Many consider them to have a more decorative finish than chamfered frames.



Flush Fitting Frames

Flush fitting frame windows feature a dedicated slim-line window sash which sits flush with the outer frame. This recreates the aesthetic of a period casement timber window in a low maintenance and energy efficient option.

WHAT FURNITURE IS AVAILABLE FOR WINDOWS?

With a wide selection of window furniture from which to choose from, you can adjust the subtle nuances of the window so it's the perfect fit for your home. Regardless of whether you're after a modern or traditional appearance, the furniture of your window can go a long way in helping you to achieve either look.



Handles

Generally, window handles are fitted with locking cylinders. In most modern windows, these are espag handles which operate a multi-point locking system. Different handle colours are available.



Window Stays

A window stay is a small metal bar which is fitted onto a window to hold it in a specific open or closed position.



WHAT MAKES A WINDOW SECURE?

Whilst we've all left a window or two open whilst popping out now and again, particularly on hot days, an open window is the perfect invitation for any nearby burglars. Always keep them shut, even if you're only leaving the house briefly.

When buying new windows, you should ensure they meet PAS24:2012 certification, which is the minimum required security standard for residential properties. However, there are a number of other things you should look out for too, which are covered below.



Multi-Point Locks

They secure the window at a number of points around the frame, making it more difficult for potential intruders to find a weak point they can exploit to gain entry. Multi-point locks are engaged and disengaged via an espag window handle, which most modern double glazed windows are fitted with.



Internal and External Beading

Window glazing is held in place against the frame by a small strip known as a 'bead'. The 'bead', runs along each edge of the window sash.

In Australia, most windows are Externally beaded. Concerns that external beading posed a security risk led to it being used less frequently. However, this was seen as more of a problem on older uPVC windows. Some modern uPVC windows are beaded externally, as are many timber windows, in order to retain a traditional aesthetic. External beading on timber windows is not considered such a security risk.

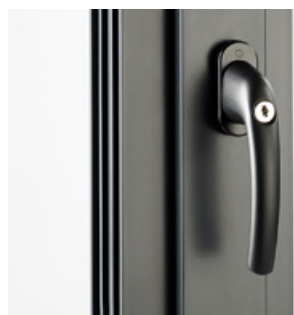

Key Operated Handle

Windows are fitted with a key operated handle which operates a multi-point locking system. Locking the window makes gaining entry more difficult, whilst it can also prevent young children from operating them. This is provided the key is kept out of their reach.



Window Restrictors

These are concealed between the window frames and can be an important safety and security measure. They work by restricting the distance that the window can be opened, which can be ideal if you have young children, as you can make it more difficult for them to climb out the window. They're also useful for those who'd like to leave the window open a tad whilst they're in the house but not situated near it.

Secured by Design



Official Police Security Initiative

Secured by Design

This is an official Police scheme, which recognises high levels of security amongst a variety of home-improvement products, including windows. Some windows are able to achieve this accreditation. Look out for whether or not it's available, if security is a major concern to you.

ENERGY EFFICIENCY AND INSULATION FOR WINDOWS

How well a window insulates your home is important; if it insulates your home poorly, more heat is able to escape, meaning more energy is required to heat your home. The problem with this being that energy costs money. So the more the use, the more you pay. Therefore, it's important to understand what to look out for when looking at how energy efficient a set of windows are.



U Values

Another method for measuring the thermal performance of a window is to look at its U-value. They are calculated by the equation W/m^2k , which measures heat loss in watts (W) per square metre of material, when the temperature (k) outside is at least one degree lower. The lower the U value, the better the insulation the material provides. For materials with a U value of 0, no heat is able to escape.



R-Values

R-values measure a material's resistance to conductive heat flow. The higher the R-value, the greater the resistance, and so the better the material's thermal insulating properties. R-values are measured in metres squared Kelvin per Watt (m^2k/W). To calculate the R-value, the thickness of the material in metres is divided by the thermal conductivity (W/mK).



Sound Insulation

If you're looking to replace single glazed windows with double glazing, you'll notice a significant difference in the amount of noise making its way inside your home. In short, your home will be considerably quieter than before. However, if you happen to reside near a busy road, a trainline or other noisy location, specific acoustic glazing is recommended as it provides additional insulation from sound.

HOW TO DECIDE ON THE RIGHT WINDOW COMPANY IN YOUR AREA

Perhaps you've decided on the right windows for you and now you've found two different companies that install them. But how do you decide which company is going to do a better job? Whilst price does have an influence from time to time, windows which are cheap without good reason, should have their quality brought into question. There are also other ways that can help you determine which installer is right for you.



Product and Installation Guarantees

When buying new windows, it's important to look at whether or not the company offers a guarantee on all the window components and the installation. If they're not prepared to offer one that covers both aspects for 10 years, it pays to steer clear of them. If a company can't even guarantee them for 10 years, what is the likelihood of them lasting for 5?

Accreditations

Who the company is accredited by gives a good indication of the quality of the business. For instance, having accreditation's Secure by Design, BSDI, AGWA, WERS, HIS & HCP, means that the company and its products have been independently audited. After all, any company can claim anything, but if such claims are not backed up by independent auditing companies it's just talk... and talk is cheap. What cannot speak cannot lie



Is the Company a Registered Building Practitioner?

By law **only** Registered Building Practitioners can carry out home renovation contracts that exceed \$5000. This gives you the peace of mind that you are dealing with an audited, qualified, professional company who has in depth knowledge of the National Construction Code (NCC). Furthermore this allows the company to provide their clients with official insurance indemnity, if for whatever reason something goes wrong with the installation or the company itself, your investment is covered.



REGISTERED
Building Practitioner

PAYING FOR NEW WINDOWS

Even if you're not considering finance, it pays to deal with a company who can offer it!

Although many consumers are reticent to use finance to fund their purchases, if a company can provide it, they can only be eligible by providing the lending institution with the following information:

5 years of Audited, Profitable Accounts

A Strong Balance Sheet

A Profit and Loss Statement proving they are an established business and not a 'going concern'

No History of Liquidation or Bad Debts.

Certified Insurance Cover for the work they carry out

Common examples of these include:

UP TO
5 YEARS
INTEREST
FREE TERMS

LOW
DEPOSIT



FOR OVER

40

YEARS

THE BEST WAY
HAS BEEN THE
ECOSTAR WAY!

YOUR COMPLETE GUIDE TO WINDOWS



FINAL CONSIDERATIONS

Replacing your windows will always add value to your home. However, be sure to speak to your window company about which ones will maintain the unique character of your property years after they're installed.

We hope this guide has provided you with all the information needed to choose the right windows for your home. However, if you'd like more information, feel free to get in touch with the Ecostar team. We're happy to answer any enquires and are available to call on **1300 963 231** or can be contacted online.

T: 1300 963 231 | E: sales@ecostardoubleglazing.com.au

www.ecostardoubleglazing.com.au