



**FLARE**  
OUTDOOR FIRES

*New Zealand's  
#1 Outdoor Fireplace*



[www.flarefires.com](http://www.flarefires.com)







## ***A few words from the founder of Flare Outdoor Fires***

### **We all want more time. For many of us this means connecting and having more valuable moments at home.**

It was this very desire that birthed the first Flare Fire. We wanted something to engage around with our growing family. We also wanted to add value to our outdoor space. I guess in both ways we wanted to invest into our future.

In our travels over the years we'd seen the South African Braai, the Croatian Peka and the Argentinian Grill. We wanted something that could cook like that, but also stand like a piece of art. Since we built that first fire we've been captured by flame, smoke, family and fun.

We have been building fires now for over 20 years and thousands of New Zealanders have been won over with the same dream. We now have offices in Australia, Canada and USA and are pleased to say that people all over the world are enjoying another great kiwi product.

We love that a Flare Fire makes you the hero of your outdoor space. It does this by creating a great looking area where people want to gather. The pumping heat of a natural concrete fire creates a special ambience. Cook pizza with your kids, or a steak with your mates and the entertainment steps up a level. If that's not enough you can literally blow peoples minds with this amazing smoker accessory hidden in the chimney.

Part of the magic is learning to slow down, and the fire really does remind us of times gone by when we took the time to be present.

*Torrey Hilton*

**TORREY HILTON, FOUNDER**  
Flare Outdoor Fires







# THE Deluxe

**The Deluxe model places the firebox directly over a single woodbox. It pumps the heat and comes with the full range of cooking options whilst taking less space.**



## DIMENSIONS [mm, weight in tonnes]

	W	D	H	Wt
<b>Deluxe</b>	<b>1360</b>	<b>720</b>	<b>2880</b>	<b>2.7</b>
Premier	2720	720	2880	3.7
Prestige	2720	720	2460	3.3
Senator	4080	720	2880	4.7
Executive	4080	720	2460	4.5

## SELECT YOUR CHIMNEY PROFILE



**BOSTON**  
Straight Shoulder



**TUSCANY**  
Curved Shoulder



## INSTALLATION

All Flare Outdoor Fireplaces are ideally installed onto a concrete foundation. You can see the Installation and Foundation Guides video here: [flarefires.com/install](https://www.flarefires.com/install)

Flare Fires are delivered with a natural precast appearance which you can finish with plaster, stone, schist or leave natural. A hearth can be added, as well as many various accessories.

**PRICE : \$8,000 (INC GST)**



# THE Premier



**The Premier is our most popular model, featuring two woodboxes and the ideal height to cook and entertain with style.**

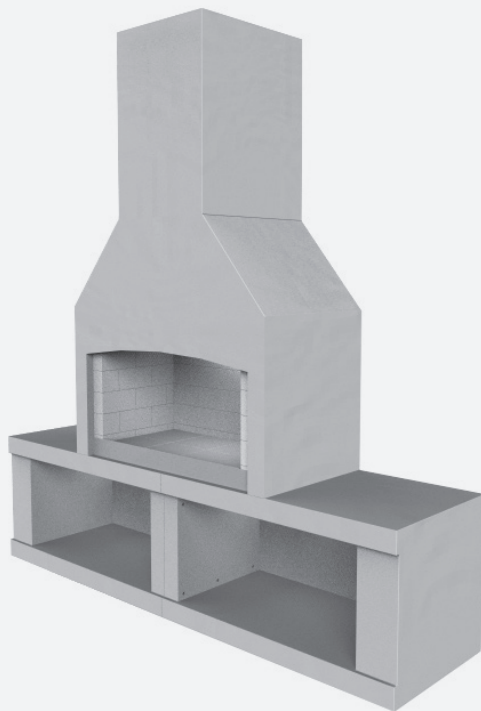

## DIMENSIONS [mm, weight in tonnes]

	W	D	H	Wt
Deluxe	1360	720	2880	2.7
<b>Premier</b>	<b>2720</b>	<b>720</b>	<b>2880</b>	<b>3.7</b>
Prestige	2720	720	2460	3.3
Senator	4080	720	2880	4.7
Executive	4080	720	2460	4.5

## SELECT YOUR CHIMNEY PROFILE



**BOSTON**  
Straight Shoulder



**TUSCANY**  
Curved Shoulder



## INSTALLATION

All Flare Outdoor Fireplaces are ideally installed onto a concrete foundation. You can see the Installation and Foundation Guides video here: [flarefires.com/install](https://www.flarefires.com/install)

Flare Fires are delivered with a natural precast appearance which you can finish with plaster, stone, schist or leave natural. The wood box tops can be polished in our factory. A hearth can be added, as well as many various accessories.

**PRICE : \$9,200 (INC GST)**





# THE Prestige



**The Prestige features two unique half-sized woodboxes sitting astride a full-sized firebox. It's the small fire that fills big spaces with uncompromising heat.**



#### DIMENSIONS [mm, weight in tonnes]

	W	D	H	Wt
Deluxe	1360	720	2880	2.7
Premier	2720	720	2880	3.7
<b>Prestige</b>	<b>2720</b>	<b>720</b>	<b>2460</b>	<b>3.3</b>
Senator	4080	720	2880	4.7
Executive	4080	720	2460	4.5

#### SELECT YOUR CHIMNEY PROFILE

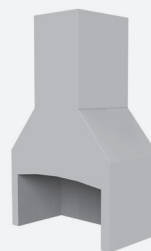

**BOSTON**  
Straight Shoulder



**TUSCANY**  
Curved Shoulder



#### INSTALLATION

All Flare Outdoor Fireplaces are ideally installed onto a concrete foundation. You can see the Installation and Foundation Guides video here: [flarefires.com/install](https://flarefires.com/install)

Flare Fires are delivered with a natural precast appearance which you can finish with plaster, stone, schist or leave natural. The wood box tops can be polished in our factory. A hearth can be added, as well as many various accessories.

**PRICE : \$10,300 (INC GST)**



# THE Senator

**The Senator model has the ideal height for cooking with plenty of working space either side of the roaring fire to prepare food or sit and relax.**

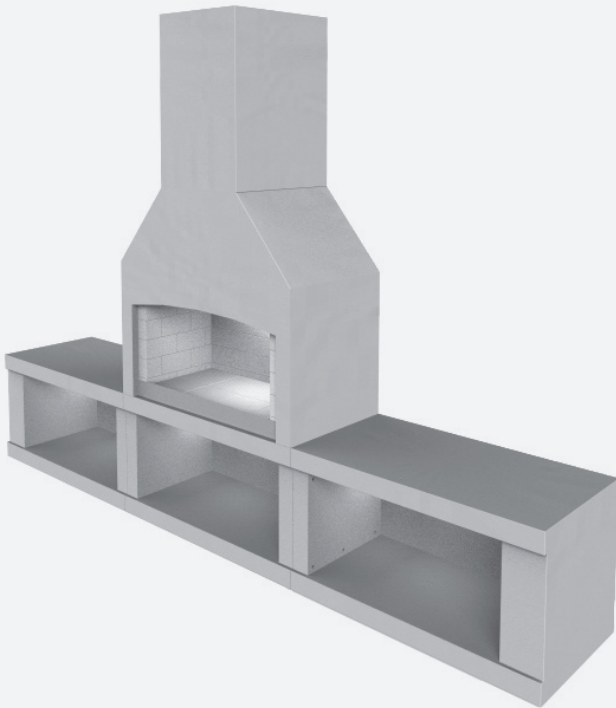

### DIMENSIONS [mm, weight in tonnes]

	W	D	H	Wt
Deluxe	1360	720	2880	2.7
Premier	2720	720	2880	3.7
Prestige	2720	720	2460	3.3
<b>Senator</b>	<b>4080</b>	<b>720</b>	<b>2880</b>	<b>4.7</b>
Executive	4080	720	2460	4.5

### SELECT YOUR CHIMNEY PROFILE



**BOSTON**  
Straight Shoulder



**TUSCANY**  
Curved Shoulder



### INSTALLATION

All Flare Outdoor Fireplaces are ideally installed onto a concrete foundation. You can see the Installation and Foundation Guides video here: [flarefires.com/install](http://flarefires.com/install)

Flare Fires are delivered with a natural precast appearance which you can finish with plaster, stone, schist or leave natural. The wood box tops can be polished in our factory. A hearth can be added, as well as many various accessories.

**PRICE : \$10,500 (INC GST)**





# THE Executive

**FLARE**  
OUTDOOR FIRES

**The Executive model lowers the heat source and makes bigger spaces look incredible. This is the ideal model for those that cook occasionally and love entertaining with style.**

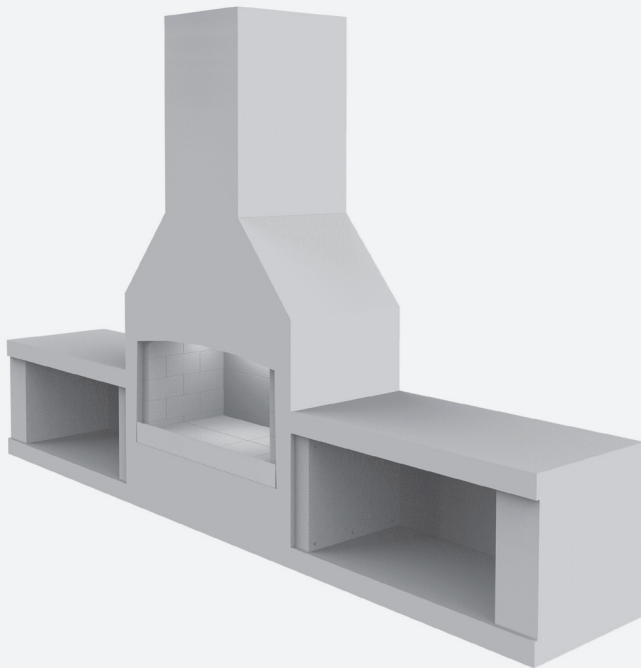

## DIMENSIONS [mm, weight in tonnes]

	W	D	H	Wt
Deluxe	1360	720	2880	2.7
Premier	2720	720	2880	3.7
Prestige	2720	720	2460	3.3
Senator	4080	720	2880	4.7
<b>Executive</b>	<b>4080</b>	<b>720</b>	<b>2460</b>	<b>4.5</b>

## SELECT YOUR CHIMNEY PROFILE



**BOSTON**  
Straight Shoulder



**TUSCANY**  
Curved Shoulder



## INSTALLATION

All Flare Outdoor Fireplaces are ideally installed onto a concrete foundation. You can see the Installation and Foundation Guides video here: [flarefires.com/install](https://flarefires.com/install)

Flare Fires are delivered with a natural precast appearance which you can finish with plaster, stone, schist or leave natural. The wood box tops can be polished in our factory. A hearth can be added, as well as many various accessories.

**PRICE : \$11,000 (INC GST)**





# THE Martello



**The Martello brings the party to your backyard! Optimise the heat and avoid the wind with our unique rotating base.**



## EVERY BACKYARD

The Martello is a COR-TEN steel fire designed to look good in every backyard. It can be lifted into place by 4 people and comes with or without the optional rotating base and pizza cooking kit.

## PRICE :

**Martello** **\$2,995 (INC GST)**

**Martello with Cooking Options** **\$3,995 (INC GST)**

*Prices exclude freight*

## COOKING OPTIONS

Includes smoking rods and trays, a cooking frame, cast iron grill plate, pizza hood kit, pizza peel, ember poker and cooking handles. This is sold as a package with a discount built in.

## DIMENSIONS [mm, weight in kg]

	W	D	H	Wt
COR-TEN Tower	770	520	2860	150kg
Concrete Base	950	950	75	150kg

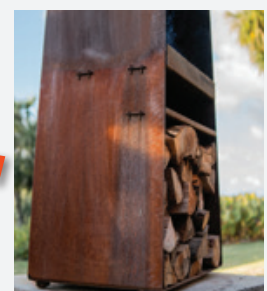





THE  
*Elite*

**The Elite is quite likely the biggest precast fireplace in the world. We are unaware of anything bigger, here in New Zealand or overseas.**

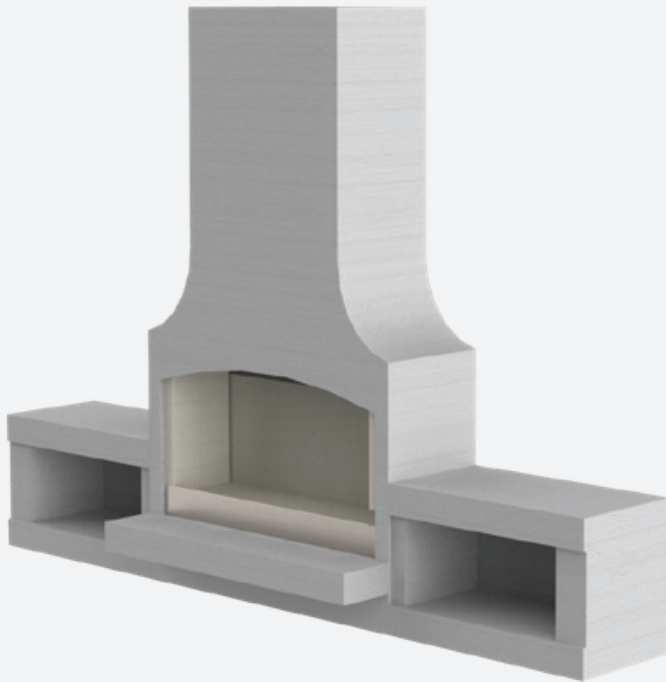

**DIMENSIONS** [mm, weight in tonnes]

	Length	Height	Firebox Opening
Elite Senator	4,080mm	3,330mm	1,760mm
Elite Executive	4,680mm	2,810mm	1,760mm



To get a sense of the scale of our outdoor fireplaces we have provided a comparison of the dimensions, relative to our original range [Signature Series].

The shadow in this picture is of a firebox from our Signature Series. It has been overlaid, so you can conceptualise the size difference. The Elite is bigger [44% bigger], but not so big that it loses its beauty.



**INSTALLATION**

Flare's Elite Outdoor Fireplaces are installed with a Hiab on a pre-prepared concrete pad. Talk to the team for more information.

**PRICE :**

**Elite Senator \$18,000 (INC GST)**

**Elite Executive \$19,000 (INC GST)**



# Accessories

**With a Flare Outdoor Fireplace you can cook and entertain with style. See our website for a full range of accessories.**



Standard Cooking Frame - **\$395**  
[includes Cooking Handles]

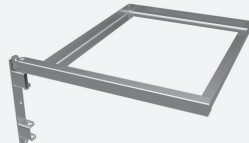

Stainless Steel Swinging  
Cooking Frame - **\$355**



Cast Iron Grill - **\$50**  
Stainless Steel Grill - **\$240**  
Cast Iron Hot Plate - **\$65**  
Stainless Steel Hot Plate - **\$150**



Log Guard - **\$260**  
[includes brackets]



Pizza Kit\* - **\$395**  
[includes Stone & Crisper]

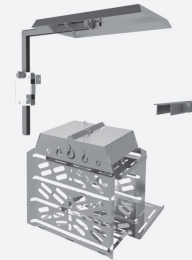

Smoker Kit - **\$895**

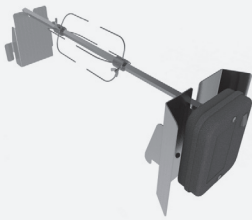

Rotisserie\* - **\$260**



Ember Poker / Rake - **\$65**



Cooking Handles - **\$95**  
[set of 2]



Night Guard - **\$695**

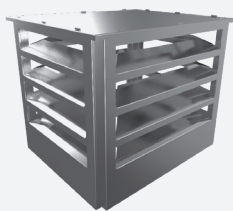

Stainless Steel Spark  
Reducer - **\$765**



Stainless Steel Chimney Extension  
500mm - **\$765**    1250mm - **\$1165**  
750mm - **\$865**    1500mm - **\$1365**  
1000mm - **\$965**    Chimney Cap - **\$595**

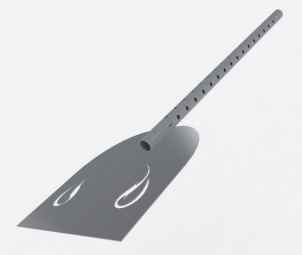

Pizza Peel - **\$125**

\*PLEASE NOTE: The Standard Cooking Frame is required for the Pizza Cooking Kit & Rotisserie



# Inspiration

Go to our website or visit our  
YouTube channel - *Flare Outdoor Fireplaces*



**Double Swing Frame Will Blow Your Mind**



**See Our Outdoor Fireplace Accessories In Action**



**How To Smoke Leg Of Lamb Over An Outdoor Fireplace**



**How To Pan-Sear Steak On An Outdoor Fire**



**Two Stunning Flare Fires in Taupo**



**Outdoor Fireplace / Outdoor Kitchen Walkthrough**



**Waterfront Walkthrough**



**Black Flare Fire Walkthrough**



# Modular by Design

**Flare Fires are completely modular. Not only does this mean you can have an outdoor fireplace assembled at your place in just hours, you can also add components to suit your situation.**



## **BEVEL**

A detail that can be added to the top of your chimney, which looks particularly nice on the Tuscany model: \$250.

## **ADDITIONAL CHIMNEY**

Additional chimney sections can be added to achieve more height. Whilst not needed for draw, they are useful for achieving extra height. These come standard at 900mm high for \$895.

## **FIREBOX & CHIMNEY**

The firebox & chimney are two separate pieces that come as a set. This image features the straight shouldered Boston. See our website for images featuring the curved shouldered Tuscany.

## **HEARTH**

The hearth is a custom option that sits between the firebox and woodboxes. A standard hearth is \$650 and provides a 150mm surface out the front of your firebox and an extended hearth is \$800 and provides a surface of 350mm.

## **WOODBOKES**

This is the Premier model, with 2 woodboxes. The woodboxes can be configured to your preference based on your available space and preferred height.

# Finish Options

Every Flare Fire comes ‘skimmed’ with a finishing compound to produce a smooth natural concrete finish that can be left as is or further coated with plaster and stone.\*



Modern polish fire

## FINISH & POLISHING

Most people leave their fire as it comes, embracing the natural look. Joins can be touched up after install with supplied product to create an attractive monolithic appearance. Wood boxes and hearths can be polished to create a great looking working surface.

## POLISH PRICE:

	MODERN	TRADITIONAL
PREMIER OR PRESTIGE	\$495	\$995
EXECUTIVE OR SENATOR	\$595	\$1,195
HEARTH	\$295	\$495
ELITE	\$795	\$1395
ELITE HEARTH	\$495	\$695

### MODERN POLISH

A light polish of the tops and front edge of the woodboxes with natural imperfections included.

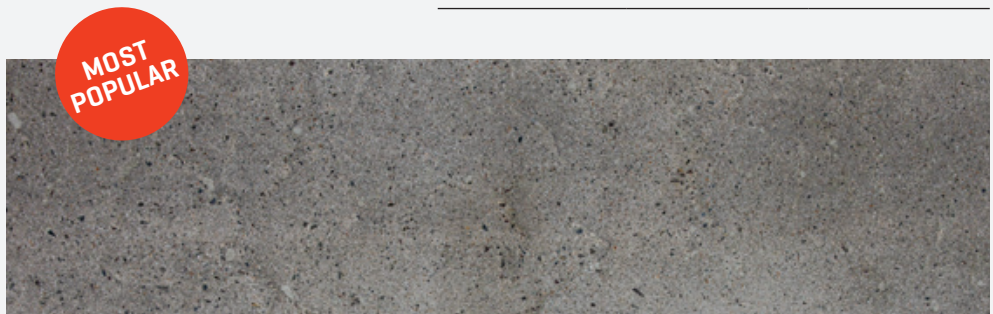

### TRADITIONAL POLISH

A deep polish of the tops and front edge of the woodboxes with natural imperfections removed.

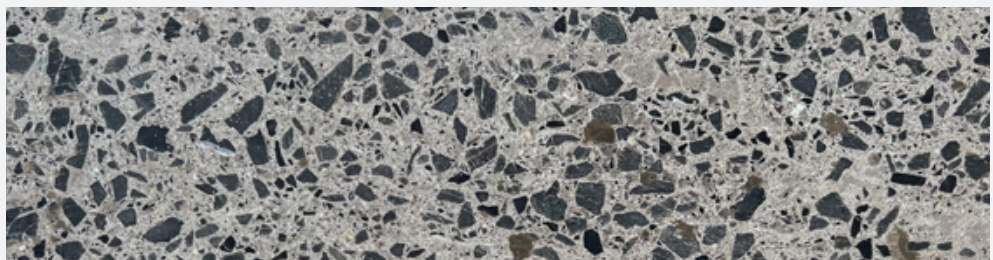

\* Back of fire is unskimmed, and can be completed on request



# New Zealand's #1 Outdoor Fireplace

Flare Fires created its first modular outdoor fireplace over twenty years ago. Whether you want an outdoor fireplace in New Zealand, Australia, USA or Canada, Flare Fires innovative, quality outdoor fireplaces are available near you.







**FLARE**  
OUTDOOR FIRES



**CONTACT US TODAY**  
**0800 FLARE FIRE**

[www.flarefires.com](http://www.flarefires.com)  
[office@flarefires.com](mailto:office@flarefires.com)